

Productoverzicht

Produktübersicht | Product overview

Dakrandpaneel

Dachrandpaneele | Roofline panel

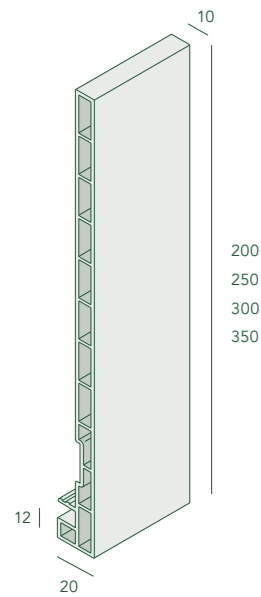

Nr. 2821 - 200 mm
 Nr. 2825 - 250 mm
 Nr. 2831 - 300 mm
 Nr. 2835 - 350 mm

Montageprofilen

Überstand Startprofil | Overhang start profile

Nr. 2867 - 10 mm
 Nr. 2877 - 17 mm

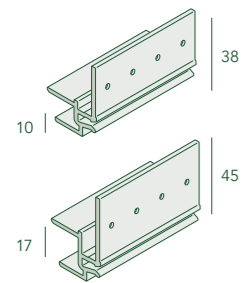

Montageprofil boeiboord

Dachrand Startprofil | Roofline start profile

Nr. 2887

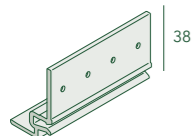

Tussenstuk

Zwischenstück | Spacer joint

Nr. 2848

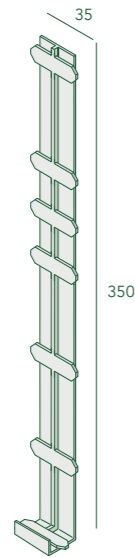

Trim/kraal aansluitprofiel

Anschlussprofil | Trim profile

Nr. 2843

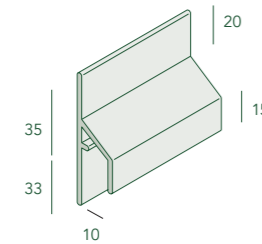

Tussenstuk sierlijst

Zwischenstück | Spacer joint

Nr. 2853

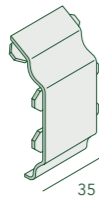

Basis eindprofiel

Basis Abschlussprofil | Basic ending profile

Nr. 2807

Nr. 2836

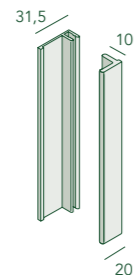

Uitwendig hoekstuk

Außeneckstück | External corner piece

Nr. 2847

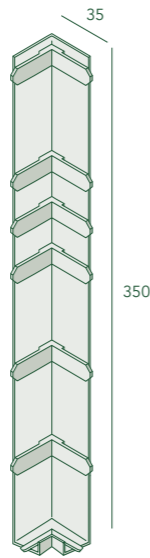

Trim/kraal sierlijst

Anschlussprofil | Trim profile

Nr. 2850

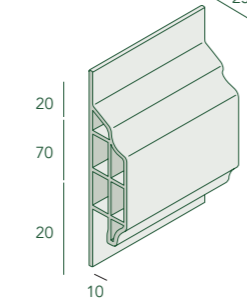

Hoekstuk sierlijst

Eckstück | Corner joint

Nr. 2852

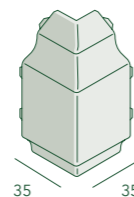

Verbindingsprofiel

Verbindungsprofil | Connection profile

Nr. 0420

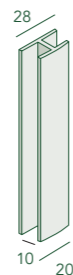

Keralit®

www.keralit.nl

Montagehandleiding dakrand

Montageanleitung Dachrand
 Installation manual roofline

Keralit®

NL

De garantiebepaling is alleen van kracht wanneer de montage van Keralit dakrandpanelen geheel volgens deze montagehandleiding is uitgevoerd. Voor principedetails kijk op www.keralit.nl/principedetails

DE

Die Garantie ist nur gültig, wenn die Montage der Keralit Dachrandpaneele ausschliesslich nach dieser Montageanleitung ausgeführt ist. Für Detailzeichnungen siehe auch www.keralitpaneele.de

GB

The guarantee is only valid if the installation of the Keralit roofline panels are installed according to this installation manual. For detailed drawings see www.keralit.nl

Verwerkingsvoorschriften

Verarbeitungshinweise | Installation guide

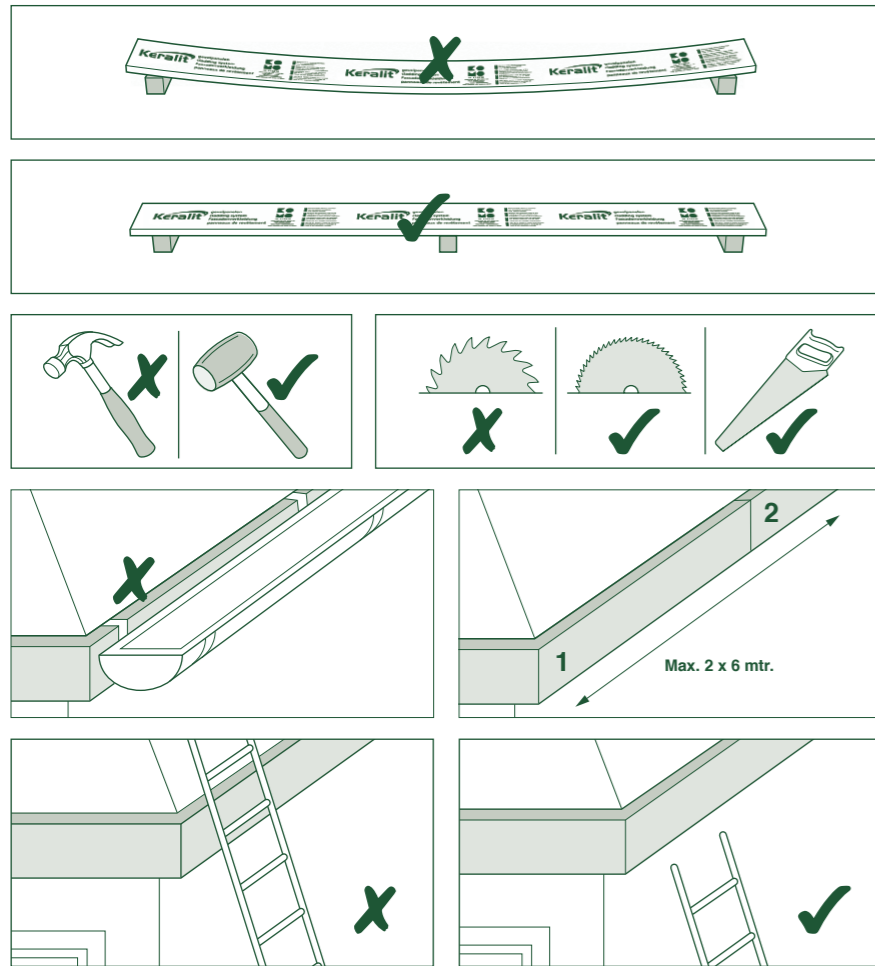

Zorg voor een voldoende ventilerende ondergrond
Sorgen Sie für ausreichende Lüftung
Always ensure sufficient ventilation

A Basismontage

Basis Montage | Start mounting

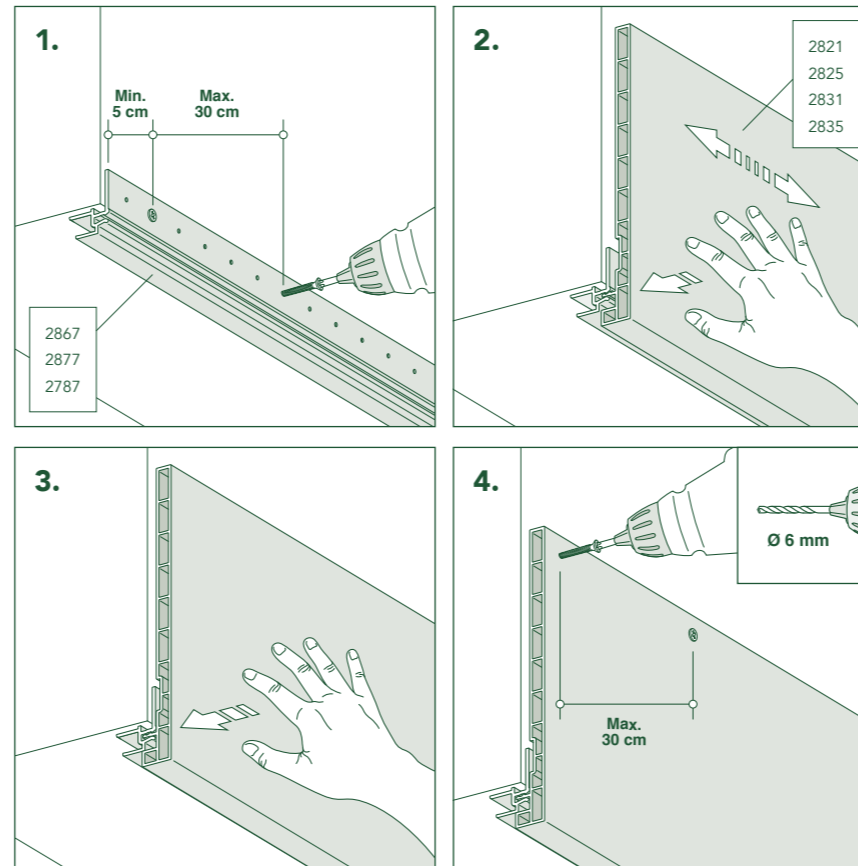

B Overstek montage

Überstand Montage | Overhang mounting

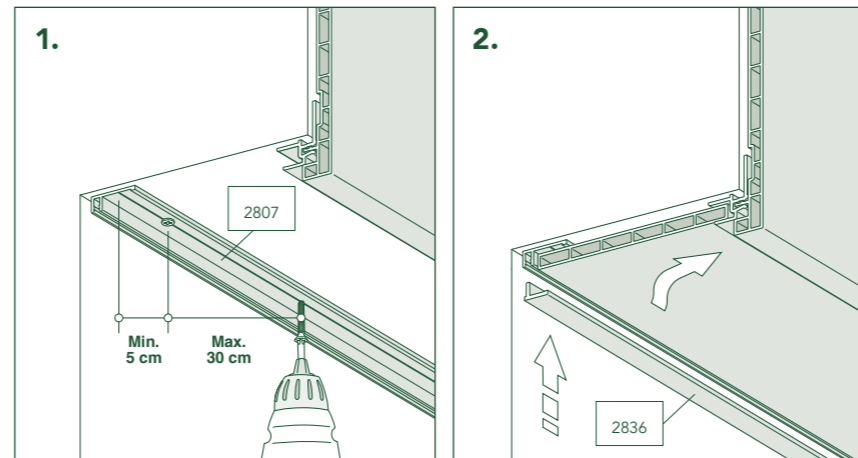

C Montage met trimkraal / aansluitprofiel

Montage mit Anschlussprofil | Mounting with trim profile

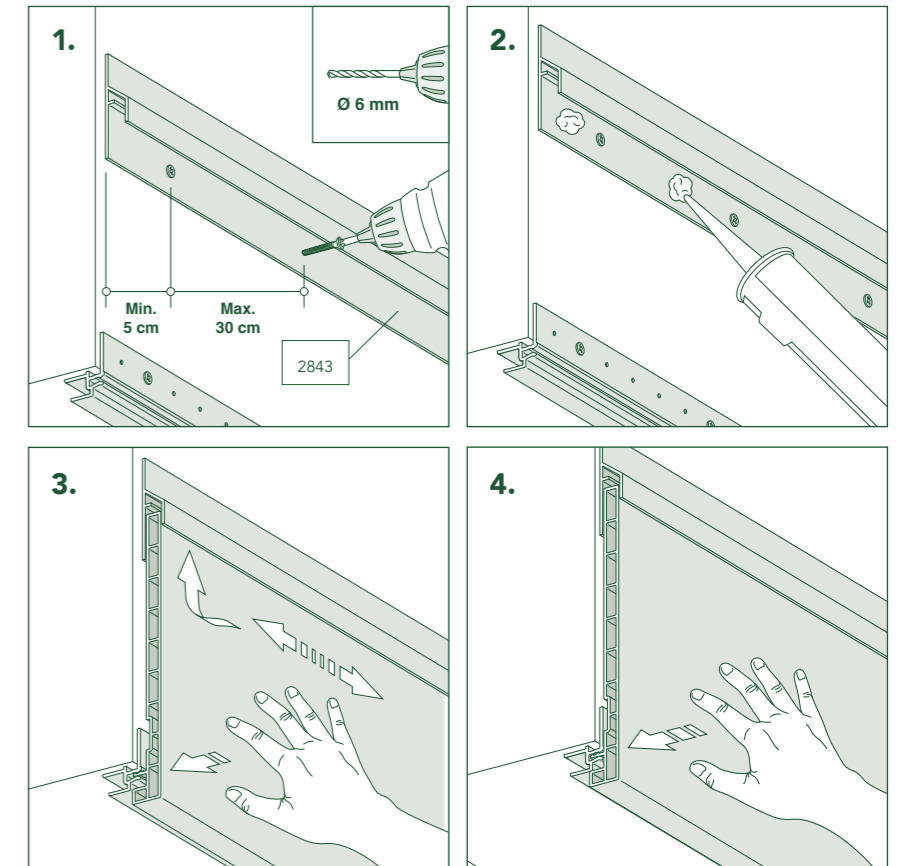

D Hoekmontage

Eckmontage | Corner mounting

